

Radiant Boilers

for Reliable Subcritical Steam Applications



RENEWABLE | ENVIRONMENTAL | THERMAL

Fossil fuels are expected to remain an important source of fuel for the generation of clean energy from new, base-loaded or cycling utility power station boilers.

Additional applications in industrial steam generation often favor coal, oil or gas as the preferred fuels. Babcock & Wilcox (B&W) is a technology leader in generating steam from these important fuels. Our design philosophy focuses on the key operating issues of availability and reliability and on incorporating leading technologies and low emissions into each new unit design. B&W's reputation and expertise are unmatched in the steam generation industry.



As a technology leader in generating steam from a variety of fuels, B&W focuses on key operating issues such as availability and reliability and on incorporating advanced technology into each new unit design.





This coal-fired plant in Indonesia features two B&W RBC boilers, low NO_x combustion system, wet flue gas desulfurization system, electrostatic precipitators and limestone material handling system.

Providing a Complete System Package

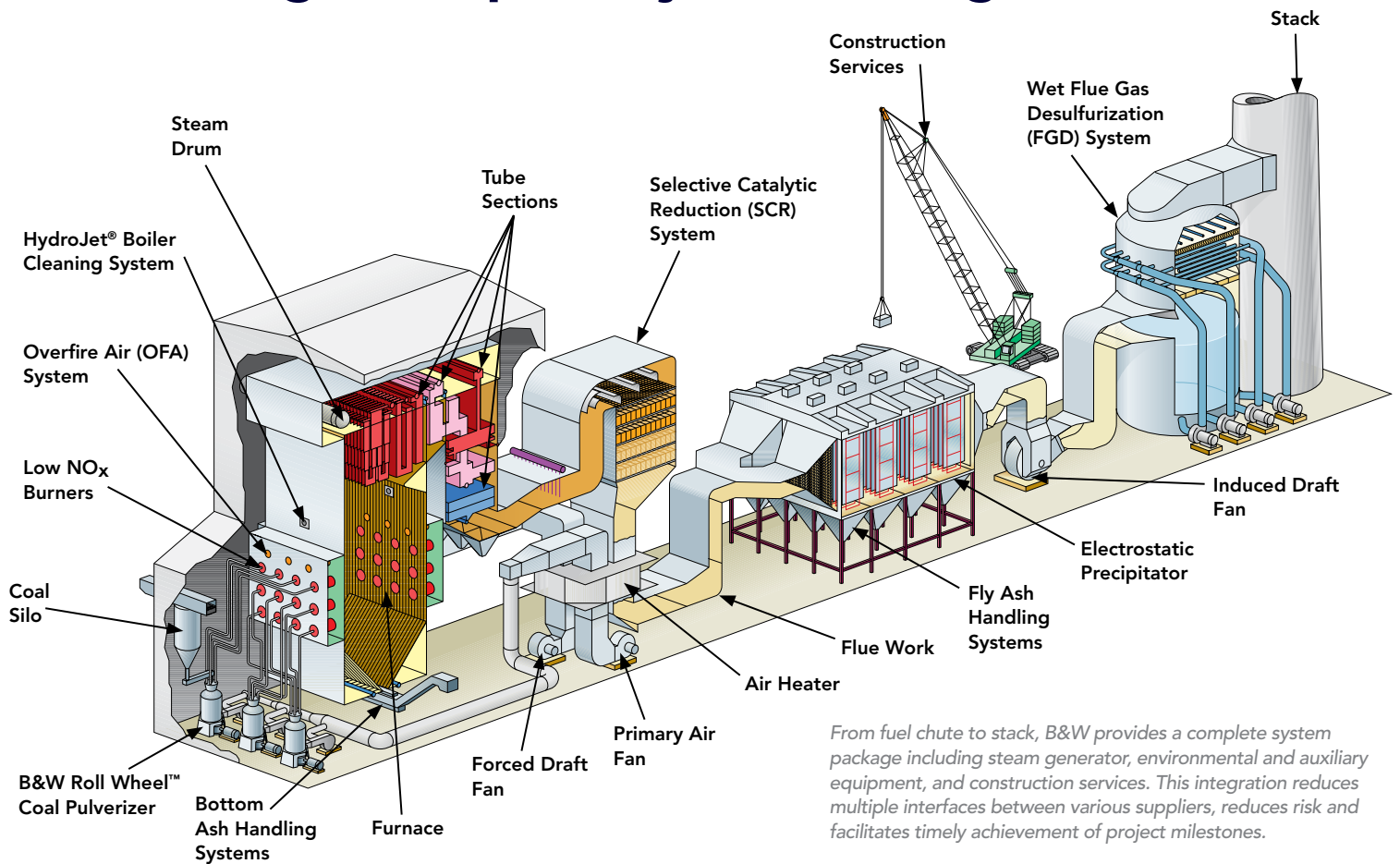

From fuel chute to stack, B&W provides a complete system package including steam generator, environmental and auxiliary equipment, and construction services. This integration reduces multiple interfaces between various suppliers, reduces risk and facilitates timely achievement of project milestones.

Reliable Steam Production

For subcritical steam applications, B&W's radiant boiler (RB) is the technology of choice. Our extensive worldwide experience in designing, manufacturing, installing and servicing more than 700 RB boilers, up to 900 MW capacity, gives our customers the dependability they demand.

B&W's RB boiler incorporates natural circulation which takes advantage of the density difference between water in the downcomers and the steam-water mixture in the furnace tubes to provide reliable cooling flow in these tubes. The cooling flow automatically adjusts to variations in heat absorption providing for a self-compensating and robust circulation design. With natural circulation, no pumps are required, so auxiliary power requirements and maintenance are reduced and availability is improved.

The RB boiler is commonly designed with a parallel back-end that allows gas biasing for reheat steam temperature control. Benefits of this design include:

- No steady-state reheat tempering spray requirements
- Reliable control of reheat temperature separate from the combustion process; this in turn:
 - eliminates interaction with combustion system optimization for nitrogen oxides (NO_x) control
 - eliminates the effect on furnace slagging characteristics
 - avoids the need for maintenance of burner tilt mechanisms

Also, B&W's surface arrangement design provides benefits for added reliability and availability, including:

- High temperature supports outside of the flue gas stream
- Minimal motion between the boiler roof penetrations
- Pendant section spacing appropriately matched for the gas temperature and coal slagging characteristics

Our vast design and operating experience gives us the unique capability to accommodate many worldwide coals and blends while meeting required steam conditions without sacrificing reliability or availability.



B&W has designed and installed more than 700 RB boilers burning a wide range of worldwide fuels.

RB Boiler Features and Benefits Summary

Features	Benefits
Natural circulation, including internally ribbed tubes and advanced steam drum internals	<ul style="list-style-type: none"> Prevents departure from nucleate boiling (DNB) and reduces furnace tube failures High steam purity for reduced turbine maintenance Reduced auxiliary power consumption and pump maintenance Improved overall boiler reliability
Large furnace arch	<ul style="list-style-type: none"> Conforms gas flow and eliminates gas bypassing at furnace exit for improved heat transfer Reduces peak temperatures and slagging potential in the superheater sections to improve availability and reliability
Wall firing	<ul style="list-style-type: none"> Even distribution of heat release across unit width More uniform flow and gas temperature at furnace exit for reduced erosion and slagging
High-temperature header design	<ul style="list-style-type: none"> Minimizes maintenance due to ligament or weld cracking
Gas-tight construction	<ul style="list-style-type: none"> No penthouse seal blower reduces power requirements and maintenance
Gas biasing steam temperature control	<ul style="list-style-type: none"> Reliable control of reheat steam temperature Improved plant heat rate for less fuel consumption, lower operating cost and lower aggregate emissions
Accommodates a wide range of coals	<ul style="list-style-type: none"> Provides flexibility in fuel choices
B&W Roll Wheel™ pulverizers	<ul style="list-style-type: none"> Reliable service for optimum steam generator performance and availability No loss of capacity with wear of the grinding elements
Low NO _x burners	<ul style="list-style-type: none"> Proven performance in reducing combustion NO_x while maintaining low CO

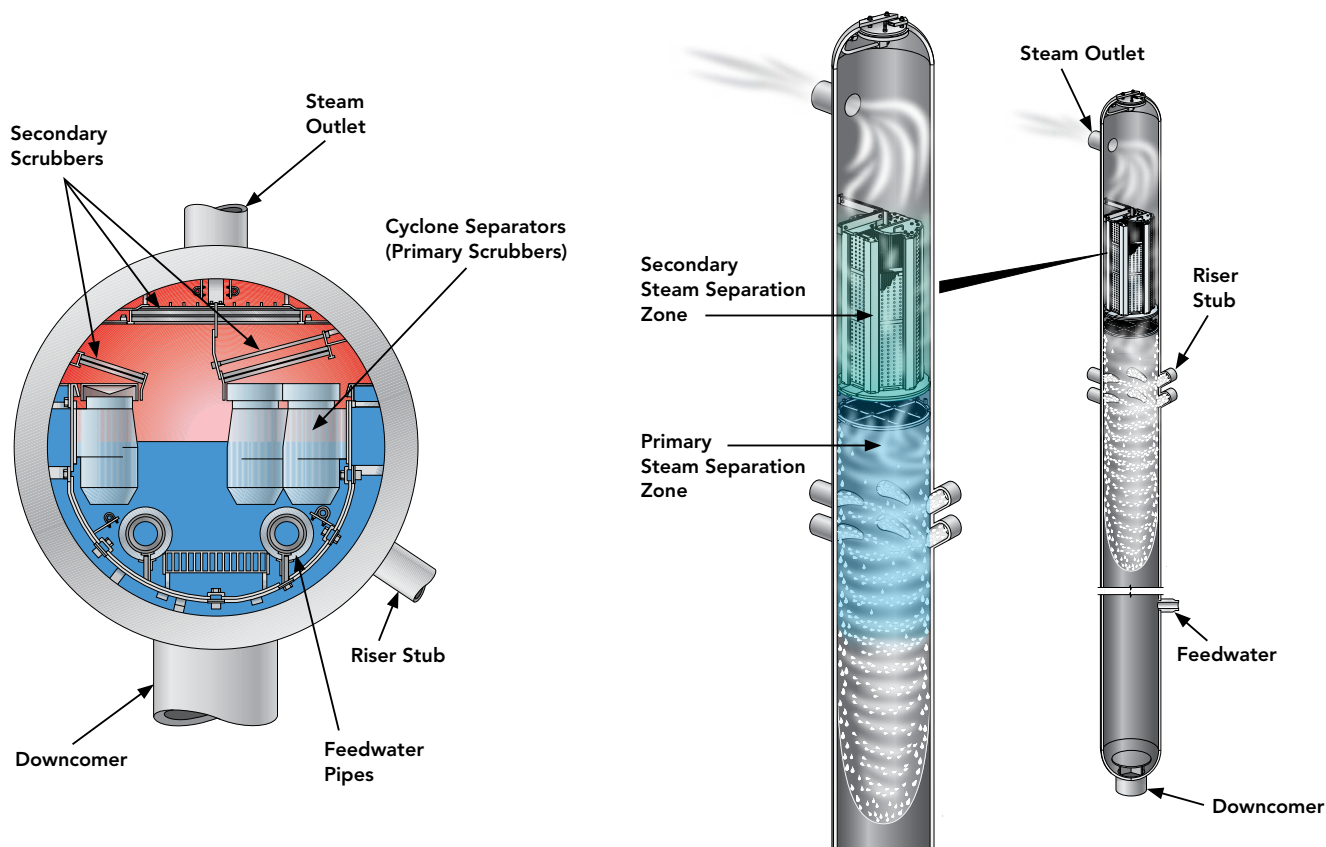

B&W's steam drums, or optional lower weight vertical steam separators, are both designed with two-stage separation to provide the most effective steam-water separation for reduced turbine maintenance and improved circulation.



Specifications to Meet Your Needs

For most base-loaded, non-cycling applications, constant pressure operation is the most economical option. However, variable pressure operation is also often specified and accommodated. B&W's radiant boiler Carolina-type (RBC) fits these applications with the following operating specifications:

- **Steam output capacity:** from 700,000 lb/h (88 kg/s) to a maximum that may exceed 7,000,000 lb/h (880 kg/s)
- **Steam pressure:** subcritical, usually 1800 to 2400 psi (12.4 to 16.5 MPa) throttle pressure with 5% overpressure capability
- **Superheater and reheater outlet temperatures:** as required, typically in the range of 1000 to 1050F (538 to 566C)

B&W offers the RB-Tower (RBT) design which is especially effective for achieving improved cycle efficiency when firing bituminous coal for boilers in the 150 to 350 MW capacity range.

We also offer RBT and RB-El Paso (RBE) boilers for subcritical applications firing oil and/or natural gas, Stirling® power boilers for smaller coal-fired applications, and circulating fluidized-bed (CFB) and bubbling fluidized-bed (BFB) boilers to fire biomass and for multi-fuel applications. And our proven supercritical designs are available for variable pressure and load cycling applications.



B&W boiler technology is available for a wide range of fuels and applications.



B&W designs its radiant boilers with a large furnace arch to prevent hot gases from bypassing the closely spaced superheater sections. This improves heat transfer and reduces the slagging potential in the superheater, thereby improving availability and reliability.

Typical B&W Radiant Boiler Carolina-Type (RBC)

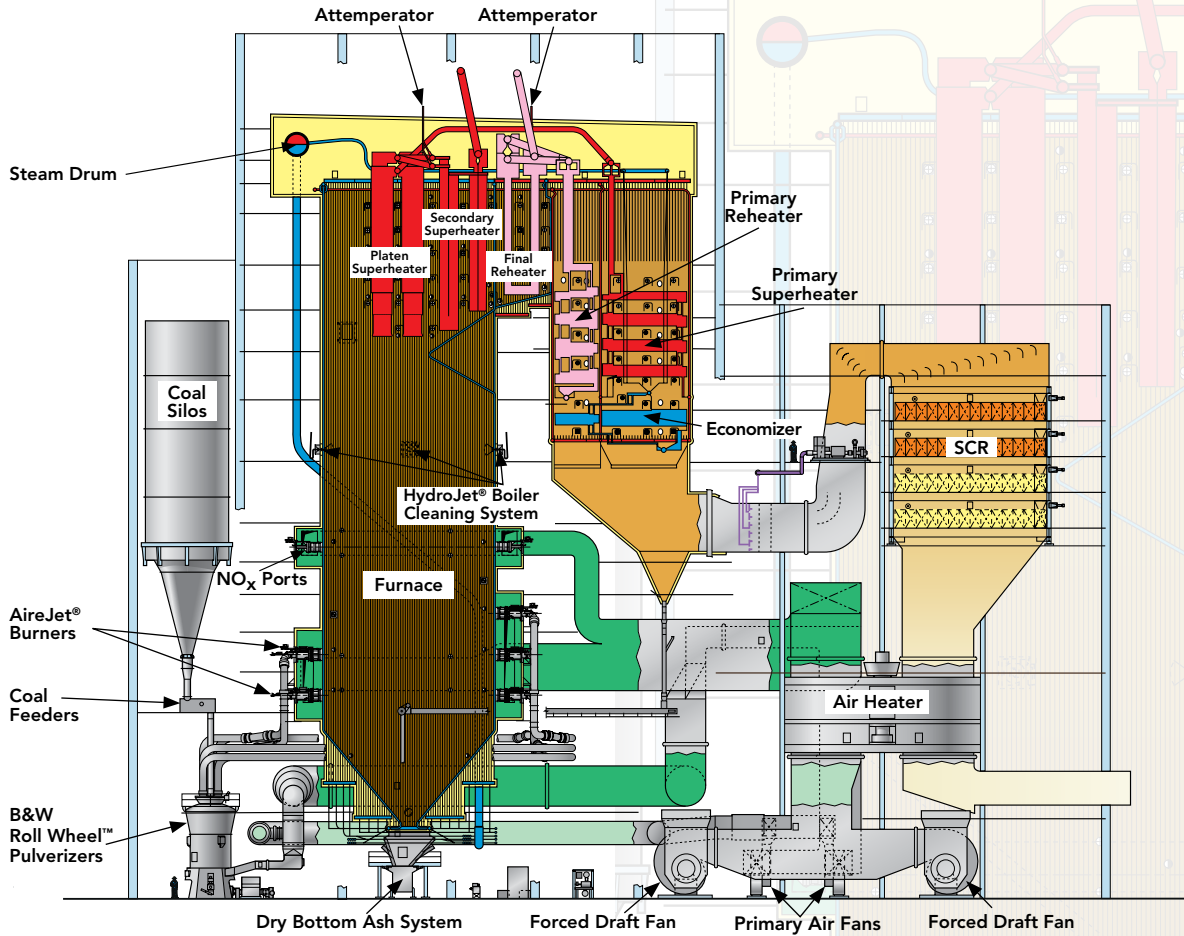

Typical B&W Radiant Boiler Tower-Type (RBT)

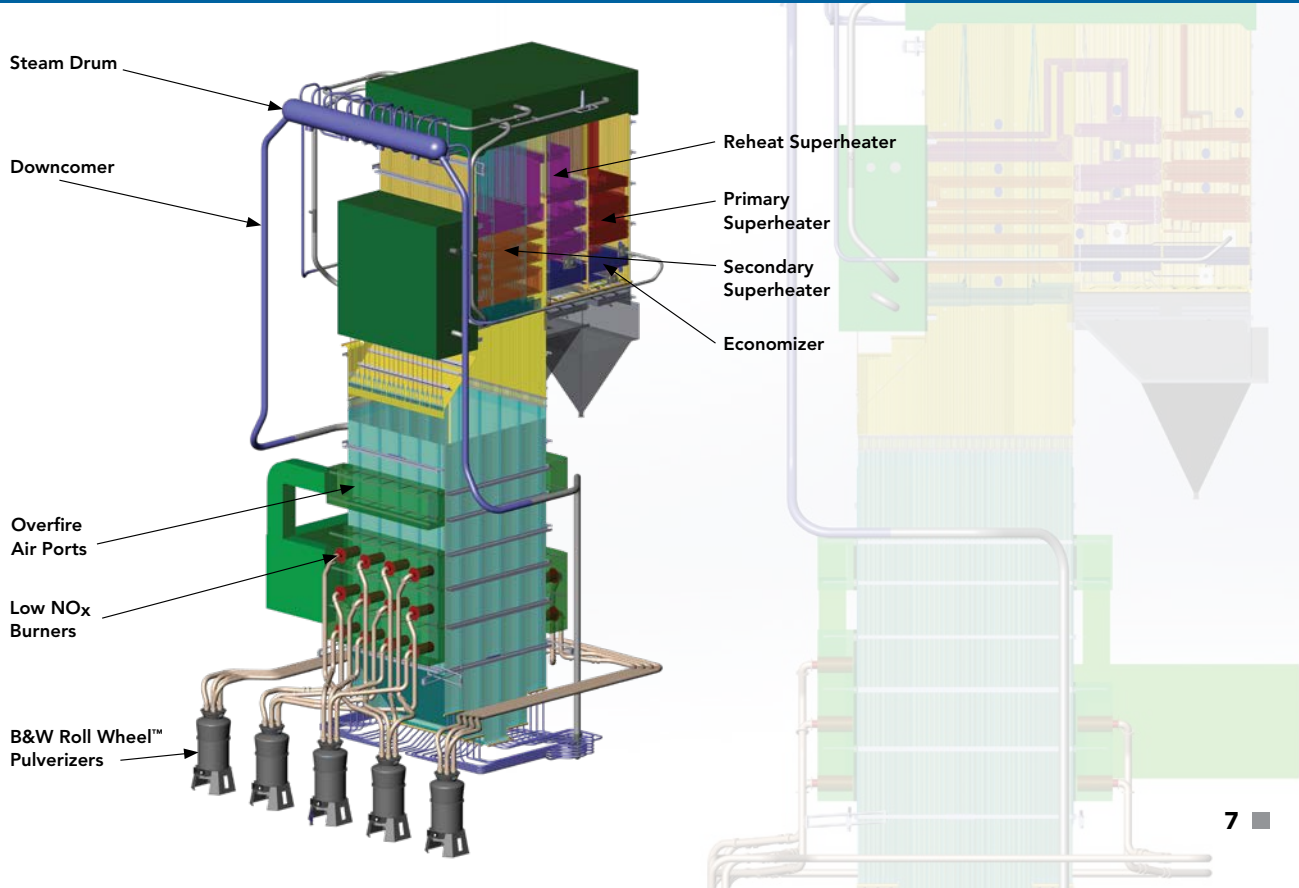

Coal pulverizing and combustion equipment play important roles in the overall steam generating system. B&W provides proven, dependable and easily maintainable auxiliary equipment such as coal pulverizers, low NO_x burners and overfire air equipment.



Achieving High Availability With Proven Auxiliary Components

A dependable boiler design alone does not assure high availability for your steam generating system. Auxiliary components must be just as reliable. B&W has the experience and technical capabilities to provide the industry's most proven boiler auxiliary equipment.

Pulverizers

The B&W Roll Wheel™ pulverizer has set the standard for value – high availability, reliability, long life and low maintenance. Our unique loading system allows the roll wheels to adjust to the contour of the coal bed. Thus, the capacity and particle size distribution remain constant throughout the lifecycle of the grinding elements. Dependable coal pulverizer operation means stable steam generator performance.

Burners

B&W's successful history of reducing NO_x emissions on coal-fired boilers includes more than 125,000 MW of low NO_x combustion equipment. The AireJet® burner, our latest offering in low NO_x burner technology, provides reduced NO_x levels, higher boiler efficiency, an improved plant heat rate, and excellent flame stability and turndown. All of our combustion equipment, including the DRB-4Z® burner and overfire air ports, feature a rugged design to ensure long life and durability.

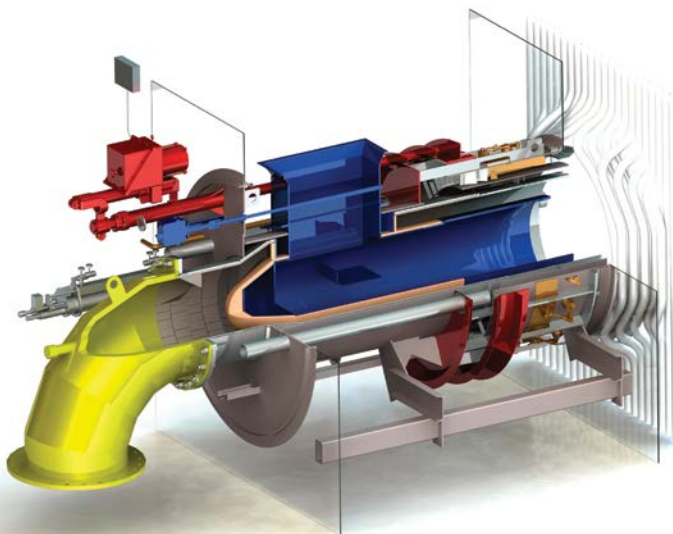

Extensive research and testing led to the development and commercialization of B&W's AireJet® burner, uniquely designed to provide optimal NO_x reduction.

Boiler cleaning equipment

Seven out of ten power plants feature Diamond Power® sootblowers, provided by B&W. We offer a variety of specialized designs using superheated steam, saturated steam, compressed air, or water to meet customer needs for precision, reliability and efficiency.



Ash handling

B&W provides Allen-Sherman-Hoff® ash handling systems, parts and service. Leading ash handling products include pneumatic, hydraulic and mechanical drag chain conveying systems, dewatering bins, and other ash handling components and systems. Innovative technologies are available to eliminate ash storage ponds.



Other auxiliary equipment

As a full-scope supplier, B&W provides other auxiliary equipment such as fans, motors, air heaters, valves and pumps for complete boiler-to-stack capabilities.



Whatever the emission, B&W has the technology to provide solutions for minimal impact on the environment.



Minimal Impact on the Environment

Reliable steam generation must be accomplished with the lowest allowable impact on the environment. B&W integrates environmental protection into its boiler design process. Our continued research and commercial development of NO_x , carbon monoxide (CO), sulfur dioxide (SO_2), sulfur trioxide (SO_3), particulate and mercury reduction technologies have led to many advancements in air pollution control.

We provide a variety of proven emissions control technologies, both combustion and post-combustion, including:

- Low NO_x /CO burners and staged combustion systems utilizing advanced overfire air ports
- Selective catalytic reduction (SCR) systems
- Wet flue gas desulfurization systems
- Dry flue gas desulfurization systems
 - Spray dryer absorbers
 - Circulating dry scrubbers
- Fabric filter baghouses
- Wet and dry electrostatic precipitators
- Sorbent injection systems for control of mercury, SO_3 and other acid gases

Incorporating the environmental control system into a completely integrated package along with the boiler allows B&W to provide an optimized system design for the highest availability, reliability, performance level and value.

Quality Manufacturing and Construction

Manufacturing and construction play an important role in taking a design to completion. B&W's global operations include several manufacturing facilities, along with its joint ventures in Beijing, People's Republic of China, and Pune, India, to serve the power generation industry with quality products. In addition, our worldwide procurement network lets us take advantage of sourcing, scheduling, labor and other opportunities that are available to provide the best overall value for our customers.

B&W's subsidiary, Babcock & Wilcox Construction Co., LLC, provides a full range of field construction, project management, maintenance and turnaround services. The latest construction technologies, planning and scheduling software, and safety programs are utilized to ensure that projects are completed safely, on time and within budget.

B&W Offers a Complete Package of Aftermarket Services

B&W's total package offering means you're working with one supplier for the entire boiler and environmental island, eliminating interfaces between several contractors. In addition, along with our expertise in providing complete boiler, environmental and auxiliary equipment systems, we are recognized as a highly reliable and responsive service organization.

Some of our many services include:

- On-site training
- Startup, testing and commissioning
- Replacement parts and inventory management programs
- Field engineering services
- Boiler condition assessment
- Equipment or plant maintenance
- Engineered upgrades



B&W's worldwide manufacturing facilities, joint ventures and procurement network let us take advantage of sourcing, scheduling, labor and other opportunities that are available to provide the best overall product quality and value.



B&W's staff of more than 130 field service engineers is available to provide technical assistance whenever the need arises.

B&W's COMMITMENT TO PROVIDE SOLUTIONS FOR OUR CUSTOMERS

spans the entire lifecycle of a power plant...from world-class project management and engineering to manufacturing, construction and replacement parts.

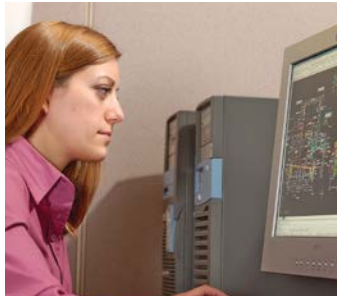

Engineering



Project Management



Global Supply and Logistics



Construction



Commissioning and Startup



Field Engineering



Replacement Parts

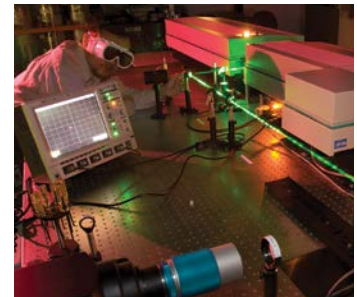

Research and Development

The Babcock & Wilcox Company

1200 E Market Street, Suite 650
Akron, Ohio, U.S.A. 44305
Phone: +1 330.753.4511

www.babcock.com



The information contained herein is provided for general information purposes only and is not intended nor to be construed as a warranty, an offer, or any representation of contractual or other legal responsibility.

B&W Roll Wheel, DRB-4Z, AireJet, HydroJet, Diamond Power, Allen-Sherman-Hoff, and Stirling are trademarks of The Babcock & Wilcox Company or its affiliated companies.



**BABCOCK
& WILCOX**

RENEWABLE | ENVIRONMENTAL | THERMAL

Established in 1867, Babcock & Wilcox is a global leader in renewable, environmental and thermal technologies and services for power and industrial applications.

For more information or to contact us, visit our website at www.babcock.com.